

# Telephone Stand

H145

# Instructions for Use

Please read and retain these instructions for future reference

v001: 23/09/20



### Dimensions

40 x30 x75cm











### Composition

Solid wood and MDF

- POSITION THIS SOFA HEIGHT TABLE AT YOUR SIDE SO YOU DON'T HAVE TO GET UP AND MISS THAT IMPORTANT PHONECALL
- INTRICATELY DESIGNED TO GIVE A VINTAGE FEEL
- 3 TIERS WITH SMALL DRAWER UNDER MIDDLE SHELF
- A GREAT DECORATIVE PIECE TO ADD SOME CHARM TO YOUR LIVING AREA

### ASSEMBLY INSTRUCTIONS / INSTRUCTIONS FOR USE:

Unpack the components carefully. Please check all parts have been removed from the packaging.

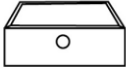
A	B	C	D	E	F	G	H	I	J	K
										
4PCS	4PCS	4PCS	9PCS	9PCS	1PC	2PCS	4PCS	2PCS	1PC	1PC

\*Calls cost 7 pence per minute plus your telephone company's network access charge

Head Office, 11 Bridge Street,  
Bishop's Stortford CM23 2JU  
Tel: 0844 482 4400\*  
Fax: 01279 756 595  
www.coopersofstortford.co.uk

**Coopers**  
OF STORTFORD

Attach 4x A to part I at the bottom, then 4x part B.

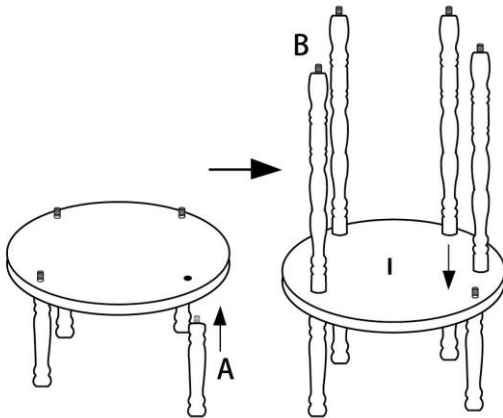

Place part I on top of the assembly and attach parts C 4x. Part K (drawer) is inserted underneath part J.

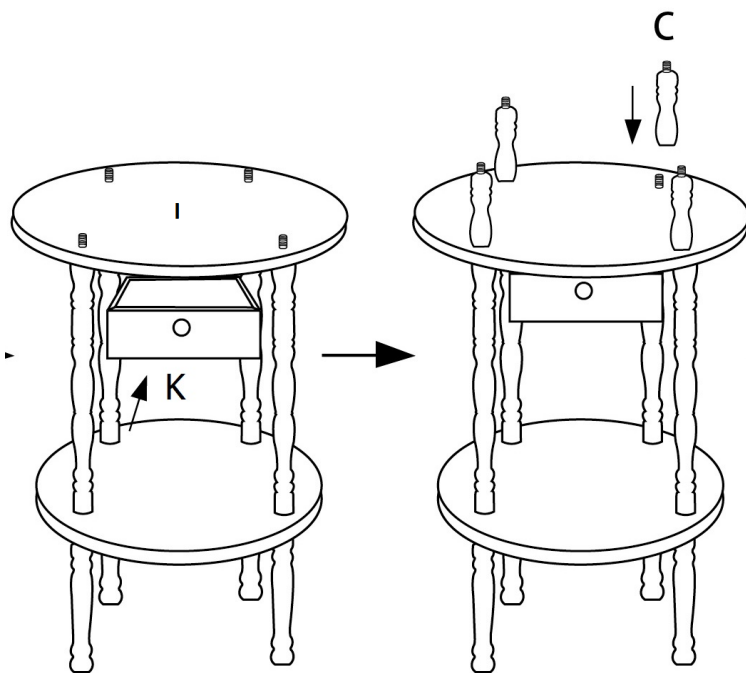

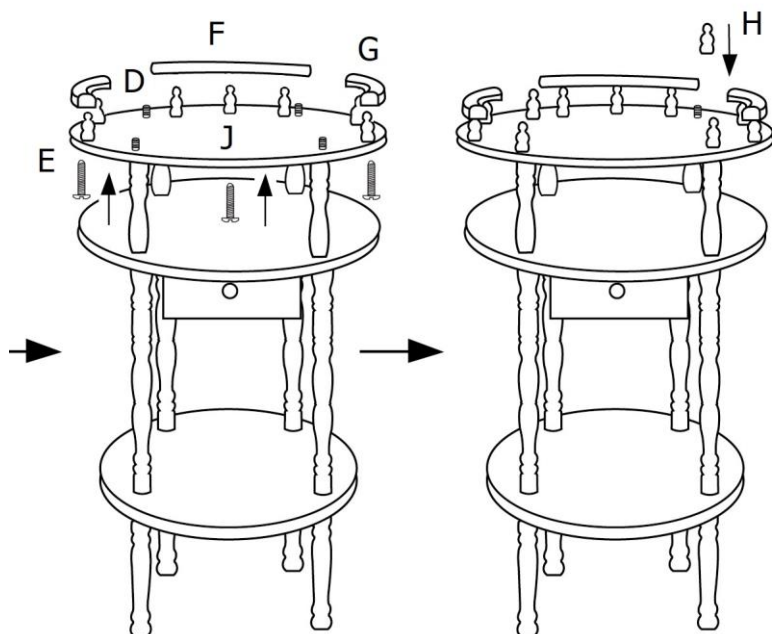

Place part J on top. Insert screw E (x9) to screw in place knobs D (x9) from underneath. Then push parts G (x2) and F (x1) in place.

## DISPOSAL

- Coopers of Stortford use recyclable or recycled packaging where possible.
- Please dispose of all packaging, paper, cartons, packaging in accordance with your local recycling regulations.
- At the end of the product's lifespan please check with your local council authorised household waste recycling centre for disposal.
- 

