

# LUXURY LUMBAR SUPPORT LOUNGER CHAIR

Item codes: R160

Instructions for Use

v001: 11/12/25

Please read and retain these instructions for future reference

## GAINSBOROUGH

Garden & Wildlife

### Dimensions:

59cm x83cm x107cm

### Max weight load: 110kg

- 5 reclining positions
- Ultra-thick & comfortable foam padded cushion with built in headrest
- Cup holder
- Folds flat for easy storage
- Contrast piping
- Straps to secure the padded cushions to the chair



### Step 1

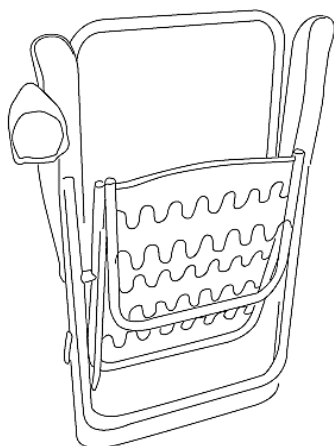

### Step 2

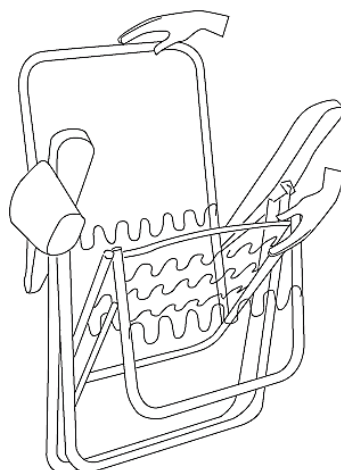

### Step 3

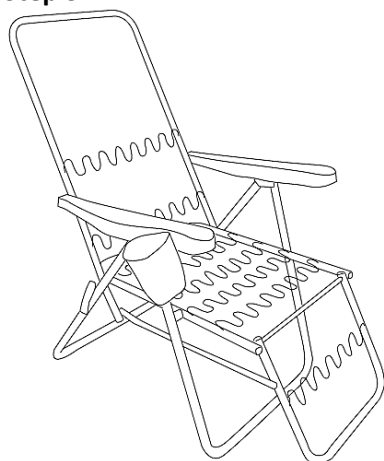

### Step 4

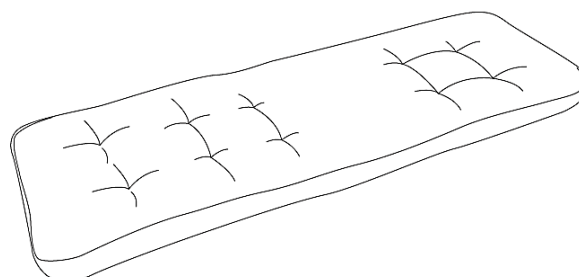

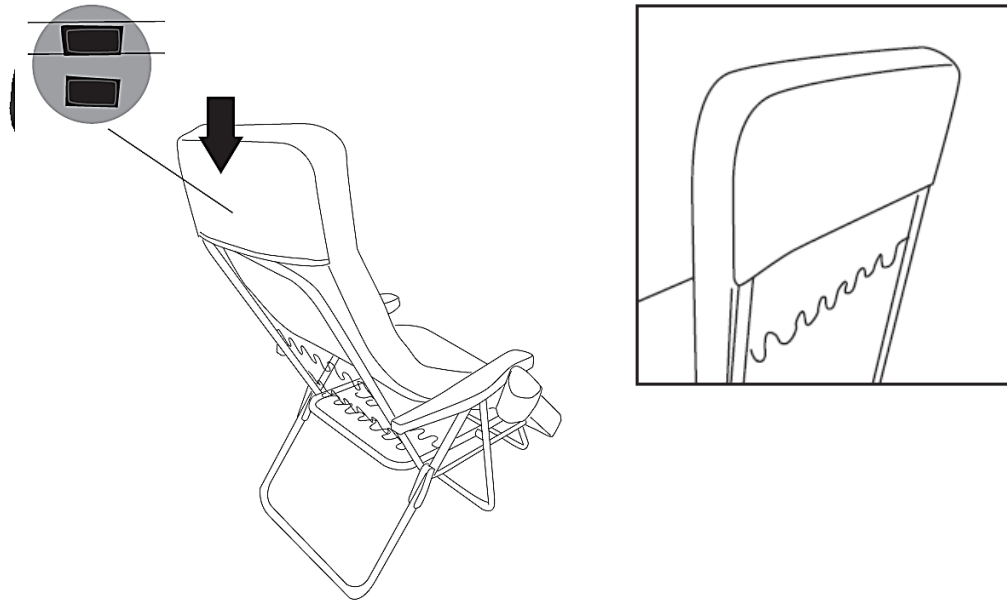

#### Step 4

Head rest attaches to chair with hook & loop fastening. The cushion must be fitted the correct way up with the padded memory foam head rest at the top.

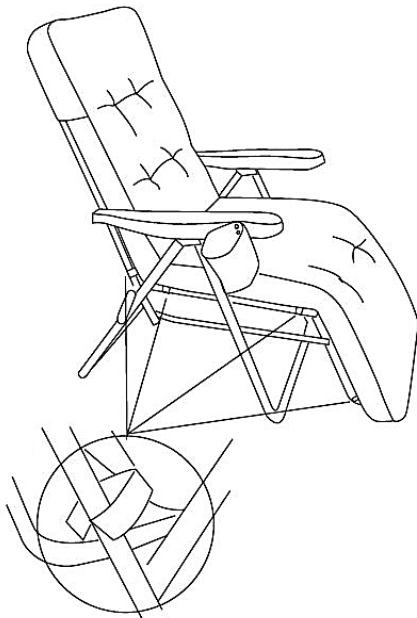

#### Step 5

Cushion is attached to chair with hook & loop fastening where indicated.

#### INSTRUCTIONS FOR USE:

To adjust the seating position whilst seated, lift the arm rest slightly and push back against the backrest to move the seat position. Release the armrests when the seat is the preferred position.

### CARE AND CLEANING INSTRUCTIONS:

Please take care when opening or folding to avoid finger entrapment.

- Protect from Adverse weather
- Store the item in a cool, dry place.
- Do NOT use abrasive cleaners or sharp utensils to clean this product.
- Wipe with a clean dry cloth.

### DISPOSAL

We use recyclable or recycled packaging where possible

Please dispose of all packaging in accordance with your local authority's recycling regulations

At the end of the product's lifespan check with your local council authorized household waste recycling centre for disposal.

Plastic Polybags – this is made from the following recyclable plastic

Code & Symbol	
Type of Plastic	Low Density Polyethylene

### Distributed by

The Enterprise Department Ltd, Trading as Coopers of Stortford.

**UK address:** 11 Bridge Street, Bishops Stortford, Herts, UK, CM23 2JU

**EU address:** D.S.B. LD, 160 Bd. De Fourmies, 59100 Roubaix, France



 0330 331 0300

 [enquiries@coopersofstortford.co.uk](mailto:enquiries@coopersofstortford.co.uk)

 <https://www.coopersofstortford.co.uk>