

3 Tier Caddy Storage

lloyd Est.
pascal 1919

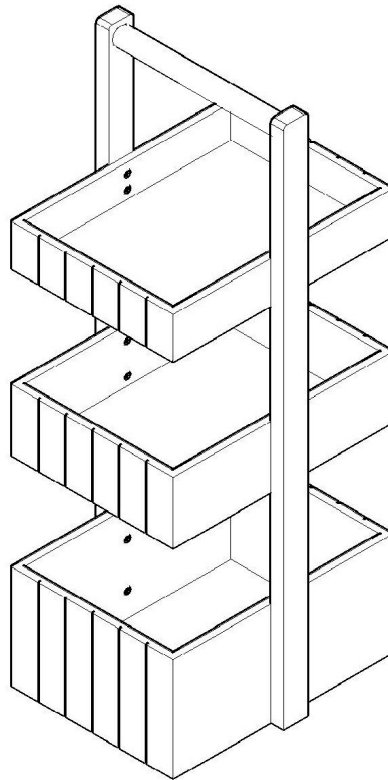

Customer Helpline

If you need help or have damaged or missing parts, call our customer helpline 0121 776 5720

Assembly instructions- Please keep for future reference- **056.94.346M**
056.96.346M



Thank you for purchasing a Lloyd Pascal Product.

Why not take a picture of your purchased LP product and post it on one of our social media pages tagging #Lloydpascal #LPfurniture #LPHome.

To view our full terms and conditions please visit our website.
www.Lloydpascal.com

Are you happy with your purchase?

Yes: That's perfect, please leave us a review on our social media channels or Trustpilot. Your feedback will help us to create future products for the next generation.

No: if for any reason your enjoyment of our product is on Hold then let the retailer that you purchased your item from know or contact us and we will resolve your issue as quickly as possible.



www.lloydpascal.com

Safety and Care Advice

IMPORTANT, RETAIN FOR FUTURE REFERENCE: READ CAREFULLY.

- Keep children and animals away from the work area, small parts could choke if swallowed.

- Make sure you have enough space to layout the parts before starting.

- This product has been constructed to be used in the domestic environment only and not for commercial purposes.

- Assemble the item as close to its final position (in the same room) as possible.

- Assemble on a soft level surface to avoid damaging the unit or your floor.



- We do not recommend the use of power drill/drivers for inserting screws as this could damage the unit. Only use

hand screwdrivers.

- Parts of the assembly will be easier with 2 people.

- Dispose of all packaging carefully and responsibly.

Care and maintenance

- Only clean using a damp cloth and mild detergent. Do not use abrasive cleaners.

- From time to time check that there are no loose screws, nuts or bolts. If there are please re-tighten.

- This product should not be discarded with household waste. Take to your local authority waste disposal centre.

Additional Guidance

- Assemble all parts and bolts loosely during assembly, only once the product is complete should you fully tighten the bolts.

- Regularly check and ensure that all bolts and fittings are tightened properly.

WARNING

In order to help prevent overturning- please follow these instructions

To help prevent product toppling over please follow the steps below:

- Must use the anti tip strap or wall fixing method provided (whichever applies)
- Do not allow children to climb or hang on the furniture
- Do not open more than one drawer at a time
- Do not place heavy items in the top drawer
- Do not place heavy items on top of the furniture, unless the furniture has been designed for this purpose

Please note that only the anti tip strap is provided. You will need to supply wall plugs and screws applicable for your wall type.

Fittings

Please check that you have all the fittings listed below:

NOTE: The quantities below are the correct amount to complete the assembly. In some cases more fittings may be supplied than required.

Bag 1

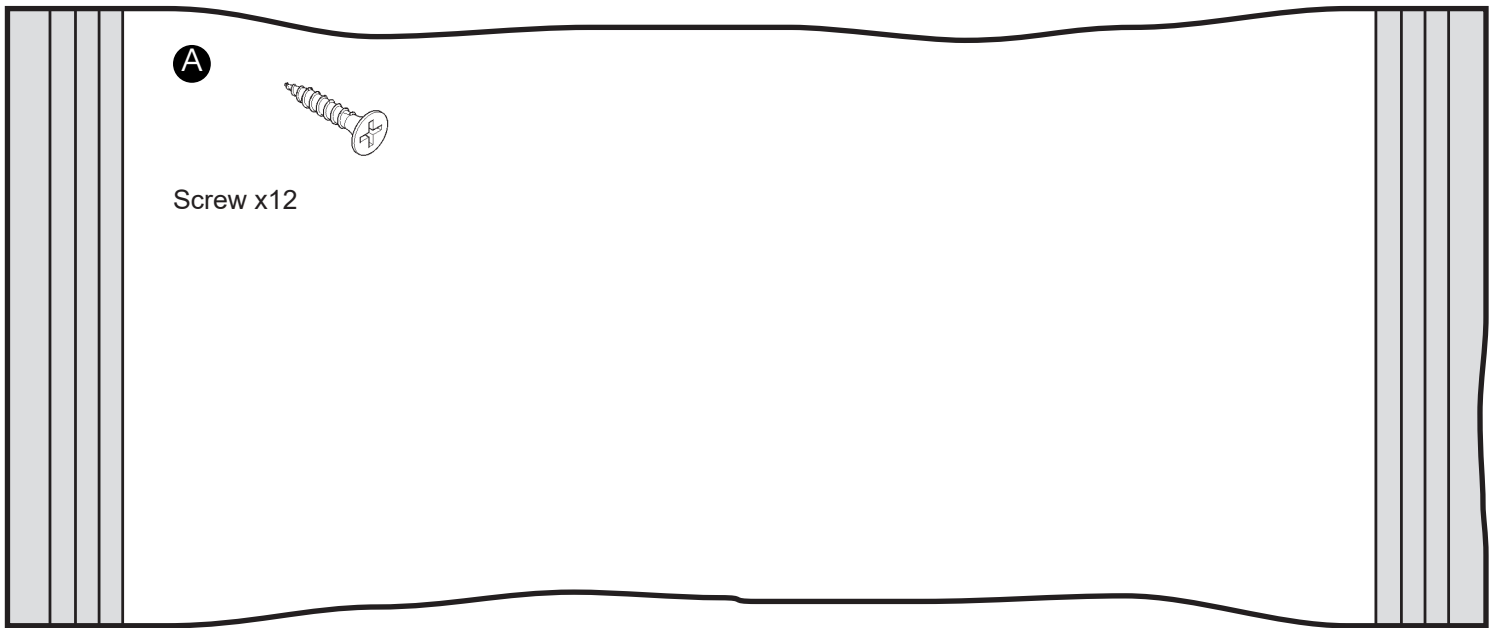

Tools required

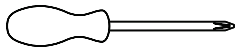

Phillips screwdriver
(small & medium)

Panels

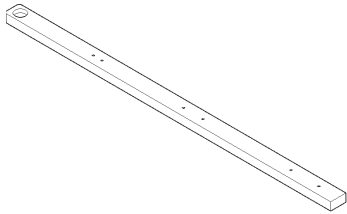

1 Side Frame x2

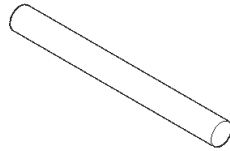

2 Top Handle x1

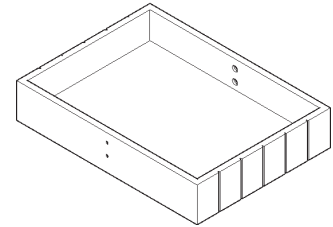

3 Top Shelf x1

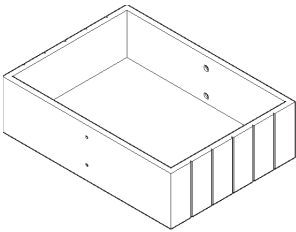

4 Middle Shelf x1

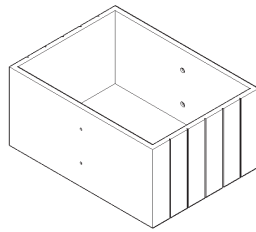

5 Bottom Shelf x1

1

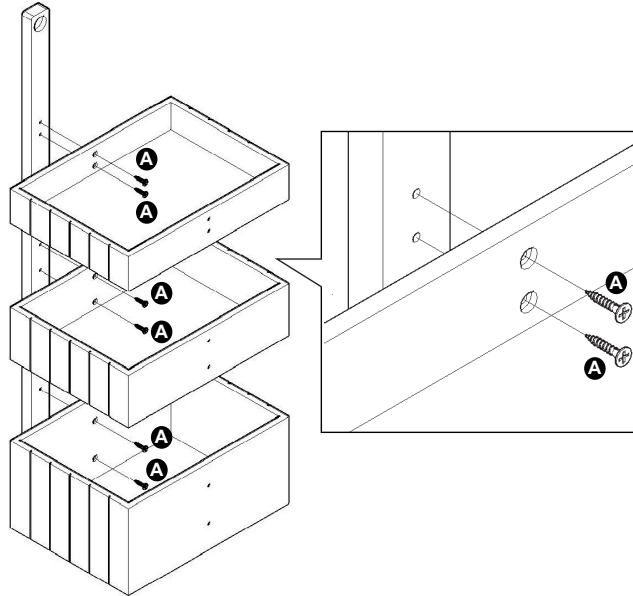
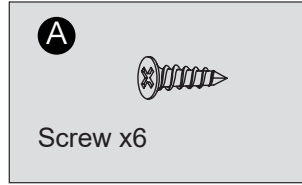
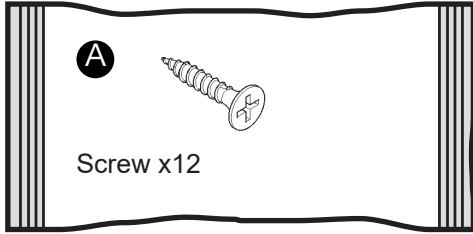

2

