

Hexagon Gazebo 10560

Instructions for Use

Please read and retain these instructions for future reference







v001: 20/10/16

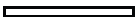

ASSEMBLY INSTRUCTIONS

PARTS

Size: 2m x2m x2m

- ①  x6
- ②  x6
- ③  x6
- ④  x6
- ⑤  x6
- ⑥  x6

 x Centre Connector

 x Base plate

 x Rope

 6 x Side corner joints

 12 x Stake

 1 x Cover

①

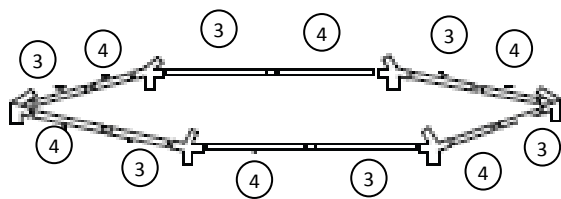

Lay out corner pieces and connect with frame (Parts 3 & 4).

②

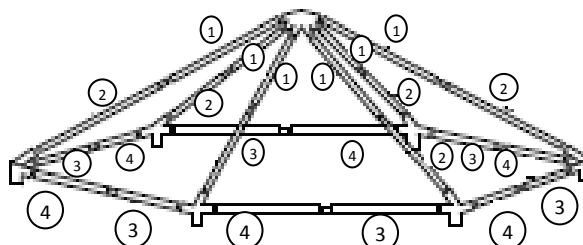

Connect tubes 1 & 2 between the centre connector and side corner joints.

③

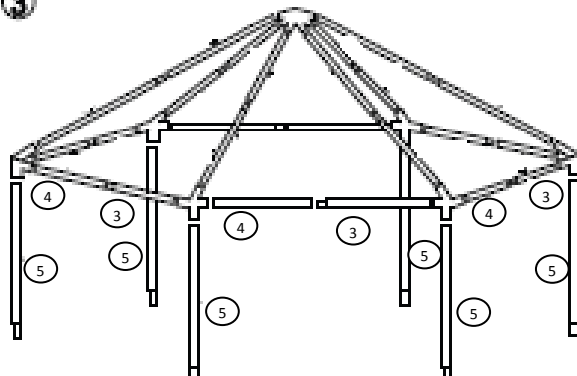

Connect parts nos. 5 with side corner joints.

④



Pull cover tightly over the roof frame.

5

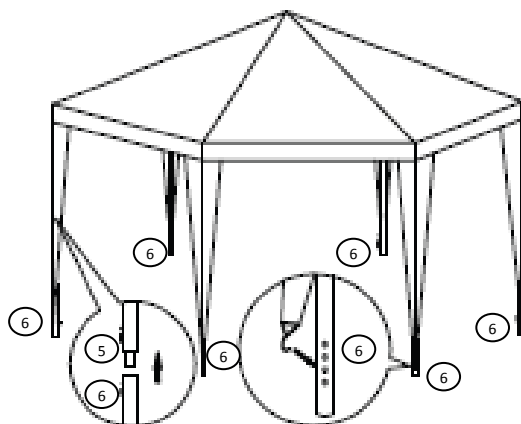

Connect parts nos. 6 with tubes nos 5 and push base plates into place.

6

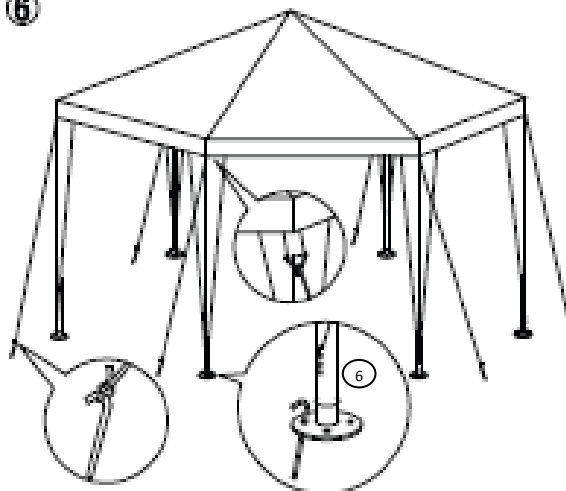

Fix ropes with stakes in top holes of each leg, and stake through one of the holes in the base plate into the ground.

WARNINGS / CAUTIONS:

- Size when opened: 2 x2 x2m.
- Do not use or try to erect in windy conditions – this may cause injury or damage to the Gazebo.
- Keep your hands away from moving parts as the frame opens and closes to avoid pinching.
- Minimum of 2 Persons required to erect.
- Ensure gazebo is completely dry before folding it up to store.

DISPOSAL:

- Dispose of all packaging, paper, cartons and plastic, plastic bags in accordance with your local recycling regulations.
- At the end of the product's lifespan please dispose of it at an authorised household waste recycling centre.